

VMR

Fast safety solenoid valve

Class A – Group 2

The VMR type valve is a fast opening single-stage solenoid valve, normally closed.

This type of device is suitable for air or gas blocking and releasing controls, required in gas power burners, atmospheric gas boilers, furnaces and others gas consuming appliances.

The VMR type valves are made in accordance with EN161 standards and the CE test certificate is issued from GASTEC (Pin 0063AQ1350).

Features

- ❑ Large range for inlet/outlet connections, from 3/8" to 6" pipes sizing.
- ❑ Provided with G1/4" pressure gauge on two sides in the inlet pressure chamber (except brass model). Others gauge points on request.
- ❑ Optional G1/8" connection for closed position indicator micro switch (on request from 3/4" to 6").
- ❑ Fine mesh filter incorporated prevents dirty contamination of the seal seat.
- ❑ Maximum operating pressure 200 mbar or 360 mbar.
- ❑ Suitable for air and non-aggressive gases (1, 2 and 3 families).
- ❑ Easy adjustable flow rate, provided with locking screw (except 4", 5", 6" and brass models).
- ❑ Qualified for continuous service (100% ED) and endless on/off cycles.
- ❑ Coil insulation is class H (180°C).
- ❑ Terminal box with PG connector or DIN plug on 1/2".
- ❑ The large models are provided with a power saving electronic device, to reduce power consumption and working temperature (optional for 1" or smaller).
- ❑ Valves are 100% tested by computerized testing machineries and are fully warranted.
- ❑ For valve identification see the following charts.

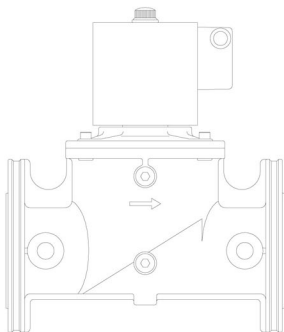

Model VMR8-3"

Technical specifications

<i>Connections</i>	ff Gas threaded ISO 228/1 from 3/8" to 2" Flanged PN16 - ISO 7005 from DN65 to DN150
<i>Voltage rating</i>	230 Vac 50/60 Hz 110 Vac 50/60 Hz 24 Vac/dc 12 Vac/dc
<i>Voltage tolerance</i>	-15% / +10%
<i>Power consumption</i>	see charts
<i>Environment temperature</i> ..	-15°C / +60°C
<i>Max. working pressure</i>	200 / 360 mbar
<i>Flow capacity</i>	see charts
<i>Seal</i>	NBR
<i>Opening/Closing time</i>	< 1 sec.
<i>Protection class</i>	IP 54
<i>Cable gland</i>	PG09
<i>Overall dimensions</i>	see charts

WARNING

- This control must be installed in compliance with the laws in force.
- Read instructions before use.
- Elettromeccanica Delta S.p.a. reserves the right to update or make technical changes without prior notice.

Operation

The VMR type valve is a safety shutting device using auxiliary power supply.

When it is de-energized, the spring pushes on the seal disc, keeping the gas passage closed. Now, the inlet chamber is under the gas line pressure, and it forces on the disc too, improving the seal.

When the coil is powered the valve opens rapidly, against the strength of the spring and gas pressure. The flow may be adjusted using the regulating screw on the top (see the *Service Instruction Section*).

If the power supply is shut off, the valve rapidly closes, interrupting the gas flow.

Accessories

A fine mesh filter is provided, to prevent dirty contamination of the seal seat. However, an external strainer must be installed upstream of the valve. Brass models are available without internal filter only.

Inlet pressure area is provided with bilateral G1/4" gauges, to connect min/max adjustable pressure switches, leakage tester or other gas equipments. On request gauges are available in outlet area from DN32 model to DN50. These are standard from DN65 to DN150. Brass models are available without gauges only.

On request, valves are supplied with a G1/8" connection on the bottom, to install a closed position indicator micro switch (from 3/4" to 6"). An adapting rod is provided too.

Coil features

The continuous service (100% ED) causes inevitable coil heating, depending of working environment. This situation is absolutely normal and has not to worry. To improve the coil cooling, install the valve allowing free air circulation.

If low working temperature is required, a power saving electronic device is available (standard on large models). It has two stages of operation: full power is supplied to the coil while the valve is opening; low power is supplied while the valve is opened.

Coil and terminal box are provided with suitable gaskets, to avoid water and dirty contamination (see the *Service Instruction Section*).

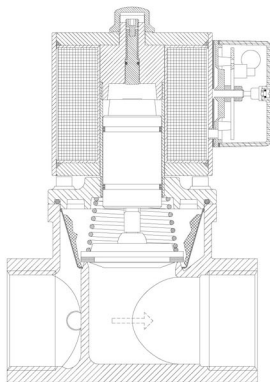

Model VMR6-2"

General information

Backpressure sealing is compliant with the *Class A*: the maximum backpressure admitted, with leakage within the EN161 requirements, is 150mbar.

Maximum torsional stresses admitted are compliant with the *Group 2* of the EN161 standard.

Avoid overtightening and mount tension free.

All components are designed to withstand any mechanical, chemical and thermal condition occurring during typical service.

Effective impregnation and surface treatments have been used to improve mechanical sturdiness, sealing and resistance to corrosion of the components.

Valves are suitable for use with air and non-aggressive gases included in the 1, 2 and 3 families (EN 437).

Materials used:

- Aluminium
- Brass
- Cast iron
- Stainless steel
- Nitrile rubber (NBR)
- Ethylene propylene (EPDM)
- Viton™
- PTFE (Teflon™)

Valve installation

Verify the line pressure is lower of the maximum working pressure admitted to the valve.

Check correspondence of flow direction with arrow printed on valve body. Check correct alignment of connecting pipes and allow enough space from the walls to allow free air circulation.

Make sure no foreign body is entered into the valve during handling.

Install in an area that is protected from rain and water splashes or drops.

Threaded models:

- Put sealing agent onto the pipe thread (avoid excessive quantities of fittings glue which could enter in the valve and damage the seal seat).
- Screw the pipes using proper tools only. Do not use unit as lever because damage to the valve stem could result.

Flanged models:

- Position the gasket and insert the bolts.
- Screw the nuts tightening them crosswise and using proper tools only.

Avoid overtightening and mount tension free.

Following chart shows the maximum values of bending moment (F_{max}), torque (T_{max}) and screws driving torque (C_{max}), according with EN13611.

DN	F_{max} (Nm) $t < 10$ s	T_{max} (Nm)	C_{max} (Nm)
3/8"	70	35	-
1/2"	105	50	-
3/4"	225	85	-
1"	340	125	-
1 1/4"	475	160	-
1 1/2"	610	200	-
2"	1100	250	-
65	1600	-	50
80	2400	-	50
100	5000	-	80
125	6000	-	160
150	7600	-	160

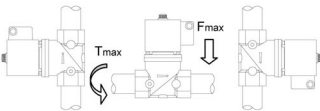

Valve may be mounted with coil in horizontal or vertical position. Coil may be oriented 360 degrees in any direction.

Electrical connections (IEC 730-1)

Check correspondence between valve voltage rating and line power supply, before making any electrical connections.

- Switch off power supply and remove protection cover.
- Connect power cables to rectifier circuit terminal board.
- Should cables pass through originally closed opening, use the rubber disc placed underneath the box plug to close any other opening. In case of 12V or 24V powered valves two entries are provided marked with the symbols "L, N" and "+,-" (except for models VMR7-8-9 and coils with plastic overinjection). With alternating voltage connect to entries "L, N". If it is rectified or direct, with entries "+,-". **Do not reverse the polarity.**
- Screw back the box cover, taking care to use all gaskets properly, because this could condition the valve life duration.

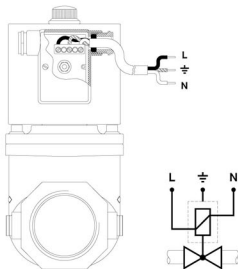

Model VMR6-2"

WARNING

- To prevent product damage and dangerous situations, read the Installation and Service Instructions carefully.
- Turn off all power before servicing any part of the system.
- Perform leak and functional tests after mounting. A gas leak detection spray may be used also.
- Coil and terminal box must be replaced with identical spare parts only.
- If the coil is turned, make sure the cap is properly tightened and the coil is locked.
- Use all gaskets properly (void warranty).
- All wiring must be in compliance with local and national codes.
- Make sure all works are performed by qualified technicians only.

Flow rate adjustment (Vmax)

Flow rate may be adjusted from 0 cubic meters/h to the maximum (excepting 4", 5", 6" and brass models).

To adjust flow rate do the following:

1. Remove coil fastener cap.
2. Using a 4 mm Allen wrench, remove the locking dowel.
3. Located under the locking dowel is the flow regulation screw. Use the Allen wrench to set it.
4. Turn wrench clockwise to decrease or counter-clockwise to increase flow rate (factory setting is max. flow rate).
5. When adjustment is completed, screw back the locking dowel and cap.

WARNING

- Make sure that capacity adjustments are made while burner is operating.
- Check the regulation is not changed during reassembly.
- Adjustments below 40% of capacity are unadvisable because they may cause turbulence.

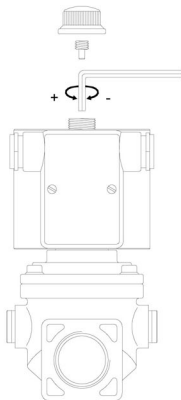

VMR3 - 1"

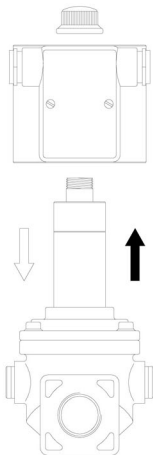

VMR2 - 3/4"

Coil replacement

Before to start with coil replacement, make sure it is the cause of failure.

To perform coil replacement do the following:

1. Make sure an identical one spare part is available.
2. Switch off power supply and remove the box cover.
3. Disconnect the wires from terminal board.
4. Remove coil fastener cap and replace the coil.
5. Reassemble following the inverse sequence.

WARNING

- When reassemble, use all gaskets properly.
- Perform functional test after mounting.
- All works must be executed by qualified technicians only and in compliance with local and national codes.

Valve identification

Connections		230V AC		110V AC		24V AC/DC		12V AC/DC	
Threaded	Flanged	360 mbar	200 mbar	360 mbar	200 mbar	200 mbar	130 mbar	200 mbar	130 mbar
3/8" brass			VMR020TN		VMR020TNB				
3/8"		VMR0	VMR02A	VMR0B	VMR02AB	VMR02C		VMR02D	
1/2" brass			VMR120TN		VMR120TNB				
1/2"		VMR1	VMR12A	VMR1B	VMR12AB	VMR12C		VMR12D	
3/4"		VMR2		VMR2B		VMR22C		VMR22D	
1"		VMR3		VMR3B		VMR32C		VMR32D	
1"½		VMR35		VMR35B		VMR352C*		VMR352D*	
1"½		VMR4		VMR4B		VMR42C*		VMR42D*	
2"		VMR6		VMR6B			VMR62C*		VMR62D*
	DN65	VMR7	VMR72	VMR7B	VMR72B	VMR72C			
	DN80	VMR8	VMR82	VMR8B	VMR82B	VMR82C			
	DN100	VMR9	VMR92	VMR9B	VMR92B	VMR92C*			
	DN125	VMR93	VMR932	VMR93B	VMR932B				
	DN150	VMR95	VMR952	VMR95B	VMR952B				

(*) Class B

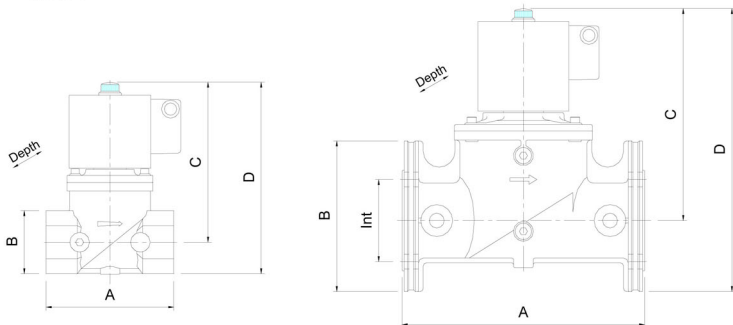

Model	Connections	Max. Pressure (mbar)	Power Consump. (W)	Overall dimensions (mm)							Weight (Kg)
				A	B	C	D	Depth	Int	Holes	
VMR020TN	3/8"	200	16	58	30	95	110	30	-	-	0.4
VMR120TN	1/2"	200	16	58	30	95	110	30	-	-	0.4
VMR0	3/8"	360	20	77	32	124	140	88	-	-	1.4
VMR1	1/2"	360	20	77	32	124	140	88	-	-	1.4
VMR2	3/4"	360	45	96	46	150	164	88	-	-	2.5
VMR3	1"	360	45	96	46	150	164	88	-	-	2.5
VMR35	1"½	360	20/80*	153	65	188	220	120	-	-	5.7
VMR4	1"½	360	20/80*	153	65	188	220	120	-	-	5.7
VMR6	2"	360	20/80*	156	77	192	230	106	-	-	6
VMR7	DN 65	360	60/240*	305	190	266	355	200	145	4x18	14
VMR8	DN 80	360	60/240*	305	190	266	355	200	160	8x18	14
VMR9	DN 100	360	80/320*	350	220	352	492	252	180	8x18	36
VMR93	DN 125	360	90/360*	460	250	430	600	310	210	8x18	58
VMR95	DN 150	360	90/360*	460	285	430	600	310	240	8x22	60

(*) Working/Opening

Loss of pressure

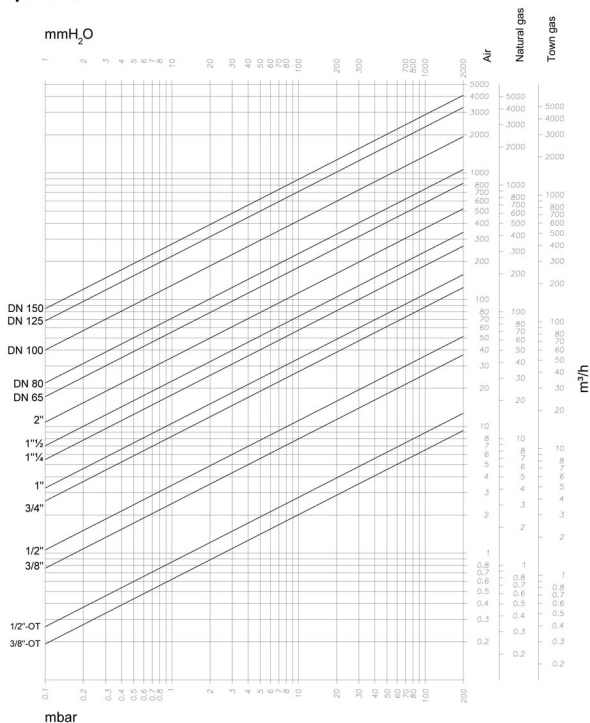

Formula of conversion from air to other gases

Gas type	Specific gravity ρ [Kg/m ³]	K
Natural Gas	0.80	1.25
Town Gas	0.57	1.48
Liquid Gas	2.08	0.77
Air	1.25	1.00

$$V_{\text{AIR}} = \frac{V_{\text{GASTOBEUSED}}}{K}$$

$$K = \sqrt{\frac{\rho_{\text{AIR}}}{\rho_{\text{GAS}}}}$$

+15°C, 1013 mbar, dry